



Technical Manual



Buffer Water Storage Tanks 25 - 120 lt

Installation, maintenance & use instructions

CONTENTS

GENERAL INFORMATION.....	4
DOMESTIC HOT WATER CONSUMPTION	4
SOLAR WATER HEATING	4
FORCED CIRCULATION SYSTEMS	5
PACKAGING	6
LABELING	7
BUFFER WATER STORAGE TANK TECHNICAL DATA.....	8
BUFFER WATER STORAGE TANK DIMENSIONS	9
GENERAL INSTALLATION RULES	10
INSTALLATION POSITION	11
GENERAL PREVENTION MEASURES.....	12
INSTRUCTIONS FOR THE INTERCONNECTION OF COLLECTORS IN SOLAR FIELDS	13
RECOMMENDATIONS ON HEAT TRANSFER MEANS AND SAFETY AND PROTECTION MEASURES DURING FILLING, OPERATION AND MAINTENANCE OF THE SYSTEM	13
MAXIMUM OPERATING PRESSURE, PRESSURE DROP, MAXIMUM AND MINIMUM ANGLE.....	13
HYDRAULIC UNIT	14
CLOSED LOOP PIPING.....	14
HYDRAULIC UNIT DESCRIPTION	14
HYDRAULIC UNIT TECHNICAL DATA	15
HYDRAULIC UNIT CONNECTION	17
POST INSTALLATION INSTRUCTIONS.....	18
CHECK LIST	19

GENERAL INFORMATION

In the present manual you will find all necessary instructions with regard to the installation, operation and maintenance of the product.

The company is active in the Solar Energy Field with high-tech equipment, ultra-modern facilities and certified products of high quality. Our experience and know-how support our cooperations, before and after sales, both in Europe and internationally.

Nowadays, the necessity for production and saving of energy without at the same time polluting the environment has become common knowledge. The planet's conventional energy resources are diminishing to a threatening level as our society's energy requirements are increasing, generating pollutants that affect the climate's balance. Renewable energy sources promise a solution to the energy problem as well as to pollution. Gradually, the international legislation is changing and encouraging - or even imposing - the use of alternative energy products, with the aim to satisfy energy requirements without endangering the environment.

DOMESTIC HOT WATER CONSUMPTION

Statistically, it is estimated that the mean family consumption is 35 to 50 liters daily per person. If we add the consumption of a washing machine and a dishwasher, when these are connected to the solar water storage tank, then each requires 20 liters per day (per wash). Thus, a family of four, for example, with a mean hot water consumption of 40 liters per person, needs an 160 liters solar system. If household appliances connected to the solar system are added, then the demand increases by at least 40 liters daily. In order to take full advantage of the solar system, maximum use of hot water should be made during daytime, so that the system can continuously produce hot water during the daylight hours, maintaining thus its maximum efficiency.

SOLAR WATER HEATING

The collecting surface absorbs solar energy and heats the liquid (water or antifreeze mixture) that circulates in the water element. This liquid is directed to the water storage tank where it heats the water. The factors that affect the temperature of the water supplied by a solar system are many and their values vary according to the season, the time of day and the location. Keeping in mind that the solar system is a system that is exposed to the weather conditions, basic parameters affecting its performance are the mains water temperature, the available solar energy and the ambient temperature. The mains water does not have a constant temperature throughout the year, being much colder in winter compared to summer. Considering 45°C as a satisfactory temperature for the domestic hot water (in order to fulfill the needs of a home) and based on statistic values, in winter the temperature of the mains water has to be increased by approximately 35°C, whereas during the summer the increase is 20°C.

Similarly, the available solar energy does not remain the same throughout the year, being much less in the winter months than in the summer months. During periods of reduced sunlight and low ambient temperatures, the solar water storage tank assures the preheating of the water and is assisted by an electrical heating element or the central heating water storage tank (triple action solar water storage tanks). As far as night-time temperature losses are concerned, these are limited as much as possible by the solar system's powerful thermal insulation. They are nevertheless affected by ambient temperatures, which vary depending on the location and the weather.

FORCED CIRCULATION SYSTEMS

Ecology - Economy - Aesthetic - Efficiency - Autonomy

With the use of solar forced circulation systems we can achieve energy savings of 70-100%, as the operating time of the buffer or the heating element is reduced depending on the sunlight of every region and the system's size, while at the same time the carbon dioxide emissions are reduced.

Central solar systems are made of excellent materials according to international specifications and have all the certificates and tests that attest their quality.

They are highly aesthetic systems, which can be simply and quickly installed to blend with the traditional or modern architecture of a building, providing free hot water almost the whole year round. Even in regions with low sunlight they achieve the preheating of the water, which contributes to a drastically reduced consumption of conventional energy.

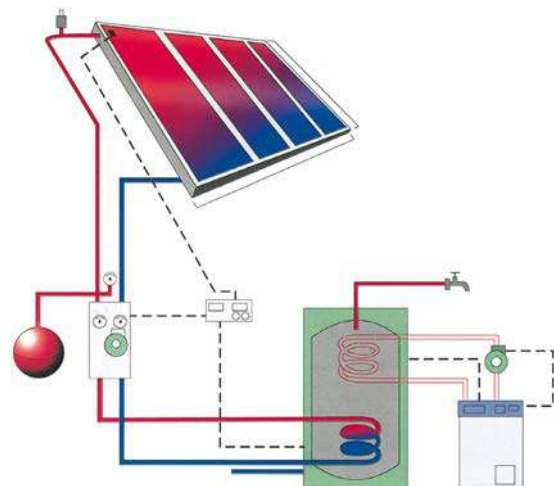
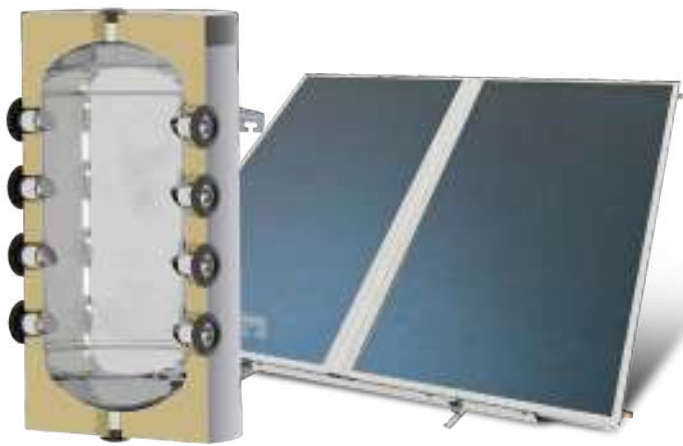

PACKAGING

Each model packaging contains all the necessary equipment:

1. Water storage buffer tank
2. Collector(s)*
3. Support base system & fittings and accessories*
4. Hydraulic Unit*

* *Optional*

The water storage buffer tank is placed over a palette and tightened with a stretch film. The collector is packed in a carton box. All the parts of the support base system, with the connection fittings, the antifreeze liquid and the other accessories are packed in a carton box. The fittings and the accessories of each appliance appears in the following table:

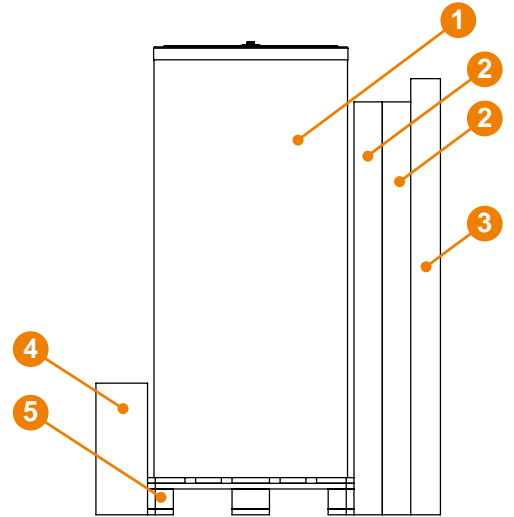

1. Buffer
2. Collector(s)
3. Support base, fittings & Accessories
4. Hydraulic Unit
5. Palette

FITTINGS & ACCESSORIES					
FITTING & ACCESSORIES FOR COLLECTORS			KIT FOR FC BUFFER TANK		
	Quantity	Description		Quantity	Description
	2 PCS	END CAP Ø22 COPPER		1 PC	HYDRAULIC UNIT - DIFFERENTIAL THERMOSTAT
	1 PC	MEC. TIGHTENED FEMALE CONNECTOR 3/4, Ø22		1 PC	COLLECTOR SENSOR (BLACK)
	1 PC	T CONNECTOR WITH MANUAL VENTILATION & SENSOR OPTION		2 PCS	WATER STORAGE BUFFER TANK SENSOR (GREY)
	2n* - 2 PCS	CONNECTOR Ø22 COPPER X Ø22 COPPER		1 PC	DIFFERENTIAL THERMOSTAT INSTRUCTIONS
				1 PC	HYDRAULIC UNIT INSTRUCTIONS
				1 PC	EXPANSION TANK
				1 PC	INOX FLEXIBLE TUBE

* n: number of collectors

LABELING

Buffer Tanks are identified by a sticker including all the details of the product.
The information provided on the sticker are important for the future identification of the product.

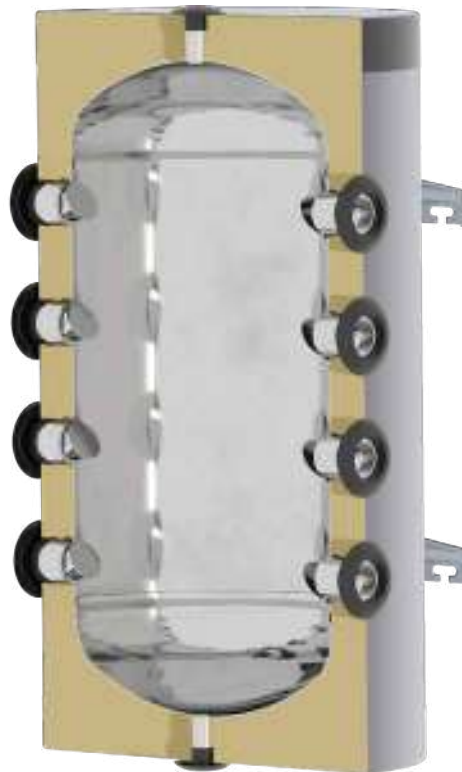

* When applied

Buffer Water Storage Tanks 25 - 120lt

BUFFER WATER STORAGE TANK TECHNICAL DATA

- **Thermal insulation:** which minimises heat losses, maintaining the hot water temperature:
 - Expanded ecologically safe polyurethane
 - Flexible removable insulation of 70mm thickness
- **External housing** of special PVC for excellent aesthetics.

MODEL		25Lt	40Lt	50lt	80lt	100lt	120lt
			Ø430-Ø320			Ø490-Ø390	
Capacity	Lt	25	40	50	80	100	120
Weight empty	kg	11	12	15	20	22	24
Insulation Expanded polyurethane	mm		55			50	
Heat Losses ΔT 45K	kW		34	38	45	51	58
Energy Class					B		
Test pressure	bar				4,5		
Max. Operational pressure	bar				3		
Max. Operational temperature	°C				95		
Internal tank material					Carbon Steel \ Enamel		



25-40lt 4-PIPE



50lt 6-PIPE

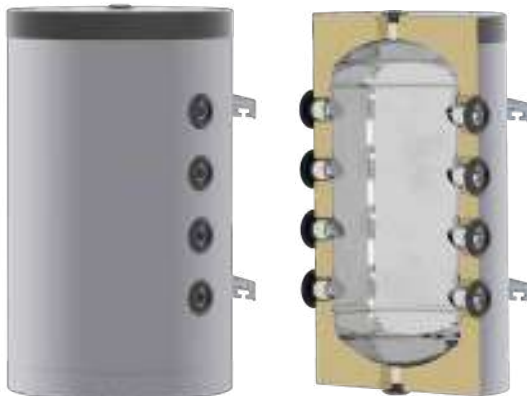

80 - 120lt 8-PIPE

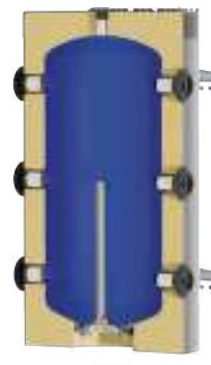

ENAMELED (OPTIONAL)

DIMENSIONS (mm)

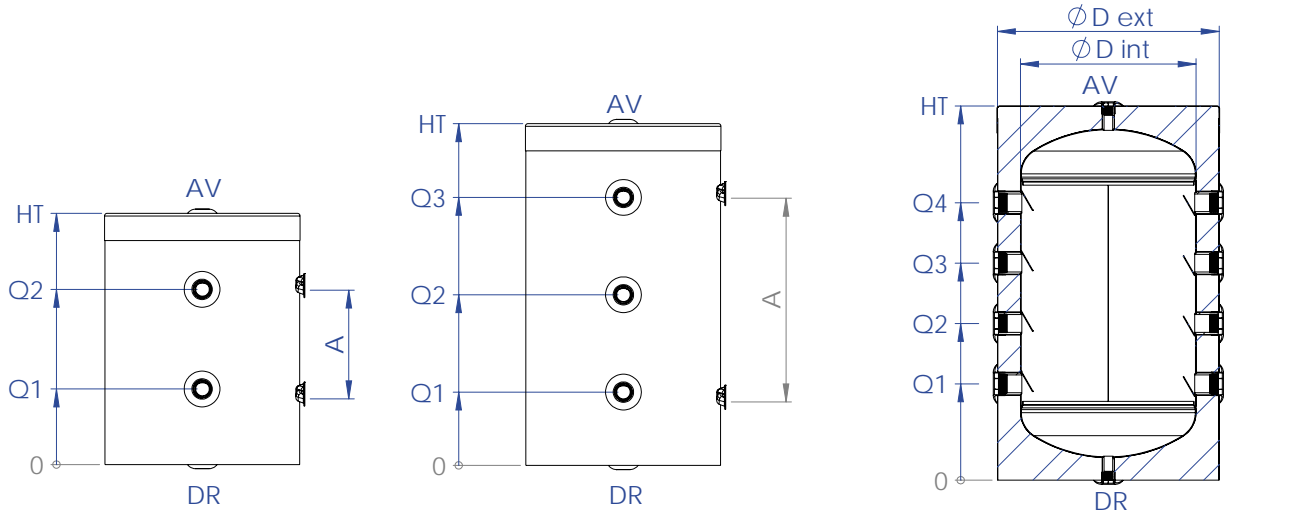

Optional Heating Element

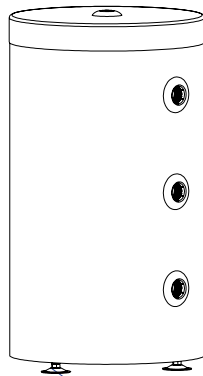
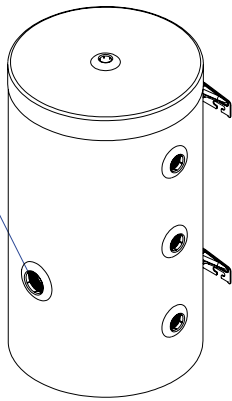

Optional Floor Standing

DIAMETER	Lt	Q1	Q2	Q3	Q4	HT	D int	D ext	A	E	B	C
Ø430-Ø320	25	167	287	-	-	455	320	430	120	443	260	330
	40	167	387	-	-	555	320	430	240	443	260	330
	50	162	377	592	-	755	320	430	450	443	260	330
Ø490-Ø390	80	214	346	480	613	827	390	490	400	503	260	330
	100	214	394	574	754	967	390	490	540	503	260	330
	120	214	444	674	904	1119	390	490	690	503	260	330

		25lt	40lt	50lt	80lt	100lt	120lt
Thermo Level	Q1-4	F 1"	F 1"	F 1"	F 1 - 1/4"	F 1 - 1/4"	F 1 - 1/4"
Air Ventilation	AV	F 1/2"	F 1/2"	F 1/2"	F 1/2"	F 1/2"	F 1/2"
Draining	DR	F 1/2"	F 1/2"	F 1/2"	F 1/2"	F 1/2"	F 1/2"

GENERAL INSTALLATION RULES

ATTENTION! Installation must be in compliance with local & national rules concerning water and electrical installations (plumbing, electricity, hygiene, urban and others).

The solar system's packaging must be removed at the site of installation in order to protect the device from shocks during its transportation, making sure that the collectors are not supported on their pipe joints. Until installation is completed, the collector's glass must remain covered until the water storage tank is filled with domestic water, so as to avoid the boiling of the filling liquid or the breaking of the glass. The plastic protective caps must be removed from the buffer water storage tank's and the collectors' pipe joints.

Installation location - shading: Prior to installation, a proper selection of the location must be made by the installer (in agreement with the customer), and the surface must be checked (taking into consideration its static resistance), so that it can bear the weight of the system. On inclined roofs the system should not be placed between two beams but above a single one. The position chosen for the solar collector installation should not be shaded by any obstacles such as trees, buildings and other all year round, so as to ensure at least 4 hours of uninhibited exposure of the collector to the sun during the midday hours.

LATITUDE	DISTANCE BETWEEN THE OBSTACLE AND THE COLLECTOR (L)
0° - 25°	1.0 x H
26° - 35°	1.5 x H
36° - 45°	2.0 x H
46° - 50°	2.5 x H
> 50°	3.0 x H

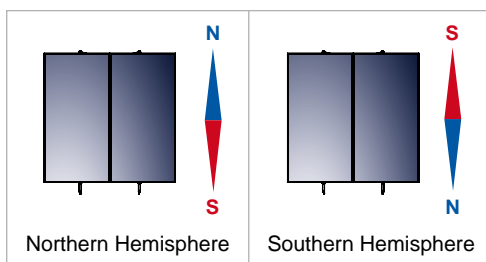
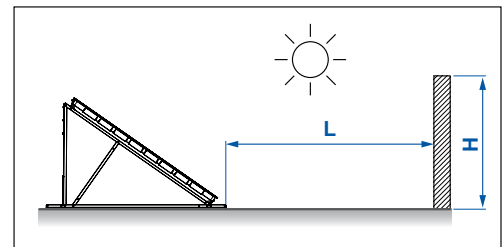

Orientation - optimum angle: a basic factor for the system's optimum performance is the selection of its angle and orientation for its particular location and the time during which the maximum gain is required.

The solar system should be positioned so that the collector's surface faces the geographical south, if the installation takes place in the Northern Hemisphere (and the geographical north for the Southern Hemisphere), i.e. it should always face the Equator.

Any deviation means a reduction in the system's performance. If a deviation from the proper orientation cannot be avoided, then the system's performance should be corrected by increasing the collector surface, following a study and evaluation of the specific conditions that apply. As the sun ray's angle of attack varies with time but also depending on the system's location, the collector's angle should be approximately equal to the installation location's latitude. At this angle the maximum energy gain on an annual basis is achieved.

Installation particularities: In case there is no compatibility between the surface where the solar collector will be installed (inclined or flat) and the standard equipment provided with the system, a different kind of equipment should be used. The responsibility for the equipment chosen lies on the installer and in no case on the company. It is up to the installer to propose & install the different equipment required, who must previously agree it with the customer.

Special weather conditions: In regions suffering from heavy snowfalls, please make sure that the snow is always timely removed. For this case and cases of regions with storms, high wind velocity, rainfall, cyclones, tornadoes, the system must be placed on the roof as firmly as possible and must be tightened with extra metal stripes. In areas where these conditions occur and hail of more than 20mm in diameter is to be observed, it is recommended that insurance for the solar collector is issued.

Piping: the routing of the piping and cabling must be agreed upon between the installer and the client, so as to ensure the proper installation of the solar system in compliance with local rules concerning water and electrical installations. Make sure that the tubes connecting the storage tank with the collector and the piping to/from the water heater are insulated in such a way that they can withstand temperatures covering the range of: -30°C to 120°C. Anti-UV protection must be used for the insulation.

Antifreeze Liquid: The special heat transfer medium used in the closed circuit protects the system from freezing and from salt accumulation inside the collector tubes. The thermal fluid must be well mixed with water in a percentage that is necessary to protect the system. The responsibility for the appropriate heat transfer medium quantity as well as for the use of other liquid than the one accompanying the solar system lies on the installer and in no case on the company. The use of water or inappropriate liquid may annul the warranty validity.

After the installation is completed, the area where the work was executed should be clean & tidy. The warranty should be filled in and the customer should sign it and immediately mail it to the company. The customer should fill in the check list provided by the company. The company does not hold any responsibility that may be the result of an inappropriate installation or incorrect use of components used for the solar system's installation.

INSTALLATION POSITION

The installation is only allowed on roofs and flat surfaces of adequate bearing capacity. Before you proceed with the installation, make sure that the roof and/or the construction is of adequate bearing capacity in terms of statics, always according to the expected maximum loads at the installation point. If the installation is in a place with an extremely big wind and snow load, the system as a whole should be statically checked by a skilled person, e.g a specialized engineer. In special cases, strengthening or more solid constructions may be required.

Space requirements for installation on the roof (TILED ROOF)

For the installation on the roof the following points must be taken care of:

- The minimum distances from the ends of the roof should be:
 - From the sides: distance equal to the width of two tiles
 - From the top of the roof: distance equal to three rows of tiles
- The minimum distance limit of 0.8 m should necessarily be respected, in order for the collectors and the mounting accessories not to be exposed to winds the power of which increases on the perimetrical edges of the roof.

Space requirements for free standing installation (FLAT ROOF)

The system should be installed at least 1.5 m away from the edges of the roof so as for:

- The systems to be accessible for maintenance reasons.
- The systems and the fixing system not to be exposed to strong winds which are developed at the ends and edges of the roof.
- The snow to be removed.

GENERAL PREVENTION MEASURES

- Please respect the instructions related to accidents prevention and the safety rules during the installation of the solar thermal systems as well as the piping.
- Please keep the work place clear and free of objects obstructing the execution of works.
- Do not let children, pets and other people to come in contact with the tools or close to the working place. This has to be respected, especially in case of existing buildings renovation.
- Store the antifreeze liquid in a safe place away from children.
- During the execution of maintenance, service or installation modification works, please remove the electrical devices and tools current collector or protect the electrical devices and electrical tools against unintended activation.
- Use only the tools intended to be used for this specific solar system. The use of other components or inappropriate tools can cause accidents.

Requirements related to the personnel

- The installation of our Solar Thermal systems can only be undertaken by authorized specialized companies and trained personnel.
- Works in electrical installations or conductors have to be executed by trained & specialized electro technicians only.

Labour uniforms

- Have protection glasses on, as well as appropriate work uniform, protection shoes, protection helmet and special long hair net.
- Do not wear baggy clothes or jewelry, as they may be trapped in movable parts.
- If, despite the use of protection glasses, antifreeze liquid comes in contact with your eyes, wash off your eyes with plenty of water and with the eyes wide open.
- Please wear protection helmet during the installation works executed at the level of or above the head.

Installation of the buffer water storage tank

- For the transportation, mounting & installation of the buffer tank use forklifts suitable for the dimension and weight of the buffer tank.
- Please protect the enameling surface from beatings during transportation and installation.
- Due to the buffer tank's weight, there is a risk of accidents. Please make sure that the bearing capacity of the ground where the buffer tank is going to be installed is adequate, when the buffer tank is full.

INSTRUCTIONS FOR THE INTERCONNECTION OF COLLECTORS IN SOLAR FIELDS

In a central collector bank, the maximum number of collectors, must not be greater than seven-eight (e.g. 14-16m²) per row. The collector banks must be connected in parallel between themselves and at a distance of 90cm (when at an angle of 25°) to 120 cm (when at an angle of 40°). At the beginning and the end of each line, there must be a valve and a 3/4" x 1/2" x 3/4" T-piece for the installation of a submersible thermometer. In addition at the end of the last row, the differential thermostat sensor be placed in place of the collector's sensor (Ø8). The temperature difference of the differential thermostat must be set to 8°C, when the buffer sensor is at the top point and to 10°C, when the buffer sensor is at mid point. For example, for a 20m² bank of collectors (i.e. 10 collectors of 2m²) we recommend: 20m² x 40 lt/m²h = 800 lt/h and Ø18 diameter piping connecting the collectors to the boiler, insulated with the respective insulation.

RECOMMENDATIONS ON HEAT TRANSFER MEANS AND SAFETY AND PROTECTION MEASURES DURING FILLING, OPERATION AND MAINTENANCE OF THE SYSTEM

For the protection of the collectors' circuit from frost, a solution of water and propylene glycol is used, which is non-toxic, at a ratio suitable to provide frost protection down to -10° within the collector at an exterior temperature of -20°.

Once the system has been placed and until the installation is complete the glass panels of the collectors must remain covered, until the buffer is filled with service water, so as to avoid the boiling of the filling liquid or the breakage of the glass.

The system must have the filling liquid replaced or topped up every 2 - 3 years. The filling must be accomplished with a suitably diluted liquid. In addition, the circuit needs the provision of a differential thermostat with a sensor for the protection of the circuit from frost which shall activate the circulation pump when the internal temperature reaches +4°C.

Additionally, under no circumstances must the automatic filling valve be left open, as there is the danger that if the collector bank has a small leak at some point which is leaking water, the automatic filling valve (if left open) will continuously top up the system with water and so the ratio of the anti freeze liquid will be altered and the collectors may break at the first sign of frost.

MAXIMUM OPERATING PRESSURE, PRESSURE DROP, MAXIMUM AND MINIMUM ANGLE

The maximum operating pressure (taking into account the increase in pressure due to the water's expansion) must not exceed 400 kPa. The ideal water flow in a central system is 40 lt/m²h to 70 lt/m²h and the pressure drop per meter of installed pipe (supply and return to the collectors) is 30mm of water. This is the data that is used for calculating the dimensions of the circulation pump in each installation.

NOTE: To the pressure drop of 30mm of water per meter of installed pipe one must add 10mm of water per square meter of installed collector.

A basic factor in the optimum performance of the system is the correct selection of angle and orientation, in relation to the installation site and the period during which we want the maximum yield. The solar system must be oriented so that the collecting surface faces the geographical south for the northern hemisphere (and the geographical north for the southern hemisphere), i.e. it should always face the equator. Any deviation in the orientation means a drop in the system's performance. If a deviation from the correct orientation cannot be avoided, then the system's performance must be corrected by increasing the collector surface, after study and evaluation of the particular circumstances. As the solar radiation's angle of attack changes over time and in relation to the system's installation site, the collector's angle shall have to be equal to the site's latitude ±5°. At this angle the maximum yield is achieved on an annual basis. The system must not be shaded by trees, buildings or other obstacles so as to ensure 4 hours of unimpeded exposure of the collector area during the midday hours.

HYDRAULIC UNIT

It contains all the basic accessories required for the connection of the collectors to the buffer.

- For the connection of the hydraulic unit to the solar circuit (collectors, system heat exchanger to the inferior part of the buffer) please refer to the hydraulic diagram of solar systems.
- The connection of the expansion vessel to the safety valve of the solar hydraulic unit should have a maximum length of 2 meters, with no bends and no air accumulation points. The union nut should have a diameter of 3/4".
- After having connected the hydraulic unit, the closed loop should be cleaned. System cleaning is carried out with water for 15 minutes, by isolating the circulation pump with the two valves before and after, and by opening the two filling/evacuation valves. The valves for the connection of plastic pipes are male.
- Prior to filling the closed loop with the anti-freeze liquid it is necessary to check the sealing of all the connections. During the cleaning, for example, you can shut one of the two filling/evacuation valves and use a compression pump or water compression from the network to raise the pressure of the circuit to 5 bars for 15 minutes.

ATTENTION! The expansion tank has to be isolated to avoid surpassing the maximum operating pressure.

- The mixing of the anti-freeze liquid must be carried out prior to the filling and at a ratio suitable to resist the minimum ambient temperature at which it is going to operate.
- System filling may be executed either from the upper side of the collector by gravity or through the compression pump from the hydraulic unit. Operating pressure from 1.5 to 3 bars can be executed with pump filling or with the water compression from the network. Constantly check all ventilation points as you fill the circuit.
- All installations and the relative attachments have to conform to the current local regulations (electrical, hydraulic, building, sanitary etc.) in force.
- It is recommended to place a vessel under the hydraulic unit of a capacity suitable to collect the anti-freeze liquid that may run from the security valve. The presence of this vessel is particularly useful during the filling and ventilation phases or during hydraulic testing, as the valve opens at 6 bar.

CLOSED LOOP PIPING

- All pipes starting from and resulting to collectors must be appropriately insulated in order to resist to temperatures from -30°C to +120°C. It is also necessary to protect insulating material from UV rays.
- The thickness of insulation depends on the local climate conditions.
- To minimize heat losses, the distance between collectors and the buffer heat exchanger must be the smallest possible.
- Avoid the concentration of air. If this is not possible, the installation of an automatic ventilator at the air accumulation point. concentration is necessary.
- Pipes diameter must be from Ø18mm to Ø22mm for distances up to 20 meters and Ø15mm for distances up to 12 meters.
- All the union nuts must resist compression 6 bar and temperatures from -30°C to +200°C.
- The annual check of the equipment and its connections is mandatory.

HYDRAULIC UNIT DESCRIPTION

Pumping, regulating, venting unit for forced circulation solar systems. In the hydraulic system, hydraulic balancing, flow measurement and venting can be performed directly in the station. The built-in SETTER Inline PF valve allows the required quantity of liquid in the primary circuit to be exactly and simply set and checked. The continuous venting system meets the most demanding requirements and keeps the system free of air. Systems which are air-free and correctly balanced hydraulically guarantee optimal energy efficiency, and are thus more cost-effective in the framework of the energy-saving directives laid down by law.

Using the scale, which is pre-calibrated for glycol, the technician can set and check the exact flow-rate values on-site. Neither training courses nor expensive measuring devices are required. Installation and venting can be carried out by one person working unaided.

HYDRAULIC UNIT TECHNICAL DATA

Maximum operating temperature:

- Depression (vaporizer side): TB 160°C
- Return (pump side): TB 110°C

Maximum operating pressure: PB 8 bar

- Propulsion compression safety valve: 6 bar

Ventilation pipe: made of brass

Brass valve components

Internal parts: made of stainless steel, brass and plastic. Level index made by borosilicate material.

O Ring EPDM **weatherseals.**

Plain weatherseals resistant to high temperatures and suitable for solar installations.

Insulating material: EPP.

Thread according to DIN 2999/ISO 7 and ISO 228 standards.

Measurement accuracy: ±10% (from the final value).

Anti-freeze liquid

- Water mixture with common anticorrosive and anticoagulant additives (liquid viscosity scale $U = 2.3\text{mm}^2/\text{s}$).
- Heating and cooling water

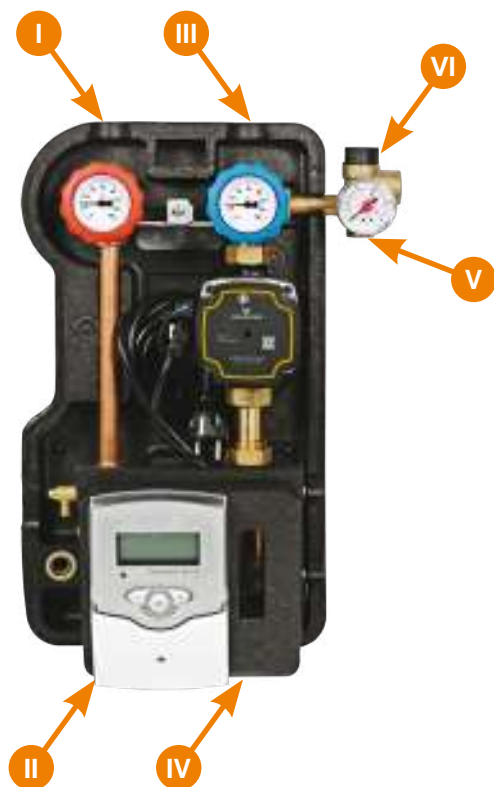

- I. Pipeline from collectors (Rp $\frac{3}{4}$ " EN 10226-1)
- II. Pipeline towards buffer (Rp $\frac{3}{4}$ " EN 10226-1)
- III. Pipeline towards collectors (Rp $\frac{3}{4}$ " EN 10226-1)
- IV. Pipeline from buffer (Rp $\frac{3}{4}$ " EN 10226-1)
- V. Connection pipeline of the expansion tank (G $\frac{3}{4}$ " ISO 228-1)
- VI. Evacuation pipeline of the safety valve (Rp $\frac{3}{4}$ " EN 10226-1)

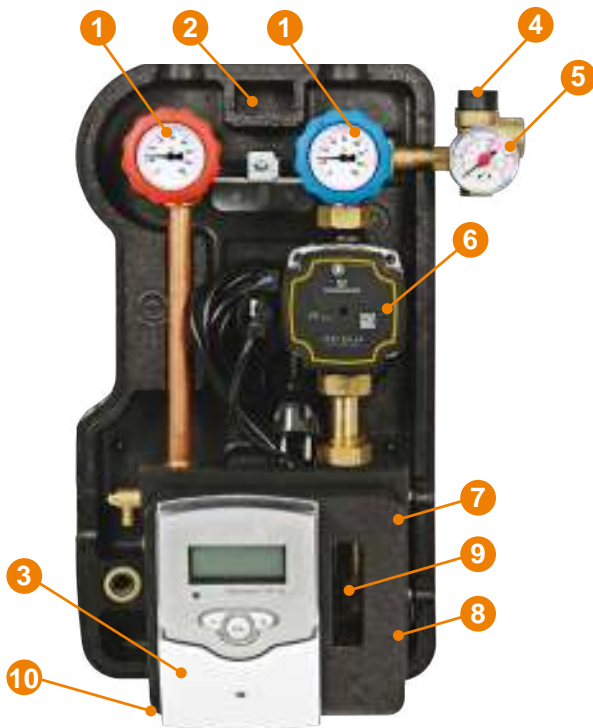

1. THERMOMETER

The thermometer with a range from 0°C to 120°C constantly indicates the medium temperature in the flow circuit. The temperature is recorded directly in the medium to minimize the reaction time. The sensor is inserted in a protective pipe so that it can be exchanged without having to empty the system. The thermometer is fitted on a special construction ball valve with an integrated non return valve.

2. WALL ASSEMBLY

For an easy installation, the hydraulic unit has a base slab.

3. DIFFERENTIAL THERMOSTAT

Checks the hot water circulator of the collectors and the burner. It has 3 temperature sensors. Measures collector and buffer water temperature. It receives many possible parameters. It can execute delayed operation start up.

4. SAFETY VALVE

The safety valve guarantees the system data protection against extreme pressures in all function phases.

5. MANOMETER

The manometer, with a range of 0-10 bar indicates the system's pressure.

6. CIRCULATION PUMP

This circulation pump, included as standard in the scope of delivery and integrated in the system, covers a large delivery range. The required operating point can be preselected using one of the three levels. A defective pump can be replaced without having to empty the system using the stop cocks on the suction side (Setter Inline PF) and the pressure side (ball valve).

7 - 8. BALL VALVE FOR THE EASY FILLING AND EMPTYING OF THE CIRCUIT

9. SETTER INLINE PF BALANCING VALVE

Precision adjustment at the balancing valve allows the required delivery quantity to be adapted to system requirements. Flow rate indication is constant, i.e. the adjustment can be immediately verified by means via the flow rate indicator. The indicator is precalibrated for a medium viscosity of 2.3mm²/s. This does away with the need for correction curves. The connection flange on the outlet side is directly screwed onto the 1 1/2" pump connector fittings which means there are no seal locations for further adapter component.

10. VENTING TANK WITH BLEEDER VALVE

Venting buffer tank with bleeder valve. The purpose of the venting buffer tank is to remove air from the medium flowing through the buffer tank. The venting tank can hold up to approx. 250 ml of air and has a bleeder valve for releasing the air. The bleeder valve is routed to the outside through the insulation which means that it can be accessed even when the insulating casing is on. The outlet has a suitable fitting for easy attachment of a hose. The frequency and quantity of the collected air can be used to check the leak tightness of the system.

HYDRAULIC UNIT CONNECTION

1. Connect the pipeline of the upper part of the collector to the hydraulic unit (position I)
2. Connect the pipeline of the domestic water heat exchanger inlet to the hydraulic unit (position II).
3. Connect the pipeline of the collector's bottom part to the hydraulic unit (position III).
4. Connect the domestic water heat exchanger outlet to the hydraulic position IV.
5. Connect the expansion tank's pipeline (to the position V).
6. Connect the evacuation pipeline of the safety valve to the position VI of the hydraulic unit.

NOTE: The safety valve should have a drain pipe connected to its outlet. This pipe should run to ground level where hot water discharge is safe and clear of any paved areas. Do not seal or block the ends of this drain pipe or the valve outlet. Antifreeze solution may be drained from this pipe during high irradiation situations.

7. Connect sensor Nr. 13 (S1 FKP 6) to the collector's upper part.
8. Connect sensor Nr. 14 (S2 FRP 6) to the lower coil sensor position.
9. Connect sensor Nr. 15 (S3 FRP 6) to the upper coil sensor position.

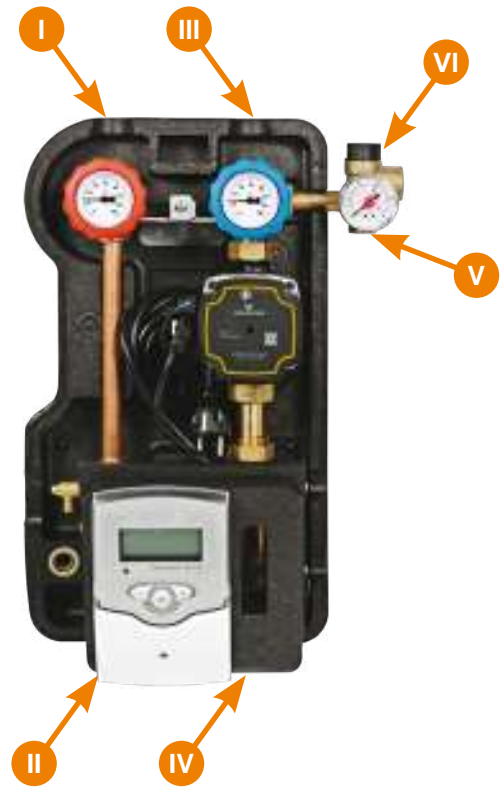

POST INSTALLATION INSTRUCTIONS

Before using the system make a final check. Open all the valves and check for any kind of leakage. Repeat the inspection after 30 minutes. Check if the system is filled with water and antifreeze fluid according to the company's instructions. In case of any failure condition a specialized technician should be called in.

The forced circulation system, in order to reach its highest efficiency rate, needs some hours (depending on the weather conditions and the solar radiation) after the completion of its installation. For this reason, even if the sun shines, it is highly recommended not to consume the hot water during the first hours following its installation.

A basic periodic maintenance will assure the long life and high efficiency of the product.

- It is recommended that the appliance is inspected in situ according to the instructions stated in the guarantee twice a year and checked for possible damage (breaking) of the collectors' glass, leaks in the connecting piping to the mains and to the consumption system, inspection of the pipe insulation and cleaning of the glass.
- If the collectors' glass is broken, it should be replaced immediately.
- It is recommended that the glass is washed at an hour of low sunlight to avoid damages due to expansion-contraction, due to temperature changes.
- If the fittings are worn (screws, pugs, piping, etc), these should be replaced at the owner's cost.
- The level of antifreeze in the closed circuit must be checked annually (as it could need topping up), to ensure the efficient operation.
- In cases where there is to be no use of hot water for long periods of time (e.g. during the summer holidays), it is recommended that the collector surface is covered with an opaque cover in order to avoid the building up of high temperatures, which could trip the thermoelectric fuse of the thermostat and cut the electrical circuit.
- During the build-up of high pressure in the thermal tank, it is possible that the safety valve will open and water will run out. This is a normal function that protects the water storage tank from high pressures. It's necessary to add a pressure reducer, safety valve and expansion tank to the mains pipeline.
- Do not switch on the electrical heating element in the following cases:
 - A) When the mains water supply has been cut
 - B) When the connecting pipes have frozen and there is no water flow from the water storage tank to the taps.

ATTENTION! Place taps with thermostatic regulation up to 38°C for hot water use to prevent burns which may be caused by the high temperature water in the installation.

CHECK LIST

INSTRUCTIONS FOR THE INSTALLER

After the installation is complete, the installer, with the help of the check list below has to check all of the points which are noted and mark in the relevant column with a \checkmark .

LIST	CHECK
COLLECTORS AND EXTERNAL PIPING	
Is the installation and the fixing of the support base according to the instructions and local regulations?	
Is there an ideal location and facing of the collectors?	
Is there humidity inside the collectors?	
Are the hydraulic connections of the collectors correct?	
Has there been good UV protection on the thermal insulation?	
Is the piping properly insulated?	
Has the installment on the roof been done according to the local regulations?	
HYDRAULIC CONNECTIONS	
Are there any leaks in the closed circuit, the connections, or in the tube heat exchanger ?	
Are the safety valves installed properly?	
Does a mixing valve of hot / cold water exist?	
ELECTRICAL CONNECTION	
Is the electric resistance connected properly? (if it exists)	
Has the electric connection been done according to the local regulations? (insulation, grounding, etc...)	
GENERAL	
Was the guarantee properly filled in and given to the client?	
Were the instructions of use given to the client?	
Was the proper selection of the model made according to the needs of the client?	
Was the client informed of other options for the production of hot water?	

Installer Data

Full name.....
 Address.....
 Telephone.....

Distributor Data

Full name.....
 Address.....
 Telephone.....

Buffer Water Storage Tanks ***160 - 1000 lt***

*Installation, maintenance
& use instructions*



NOBEL INTERNATIONAL EAD
SOLAR WATER HEATING SYSTEMS INDUSTRY

48 Vitosha Blvd., Elin Pelin 2100 - Sofia Region, Bulgaria
Tel.: +359 2 4210232 email: info@nobel.bg

www.nobel.bg